

## Fluorescent Slot, Regressed Lens

T5

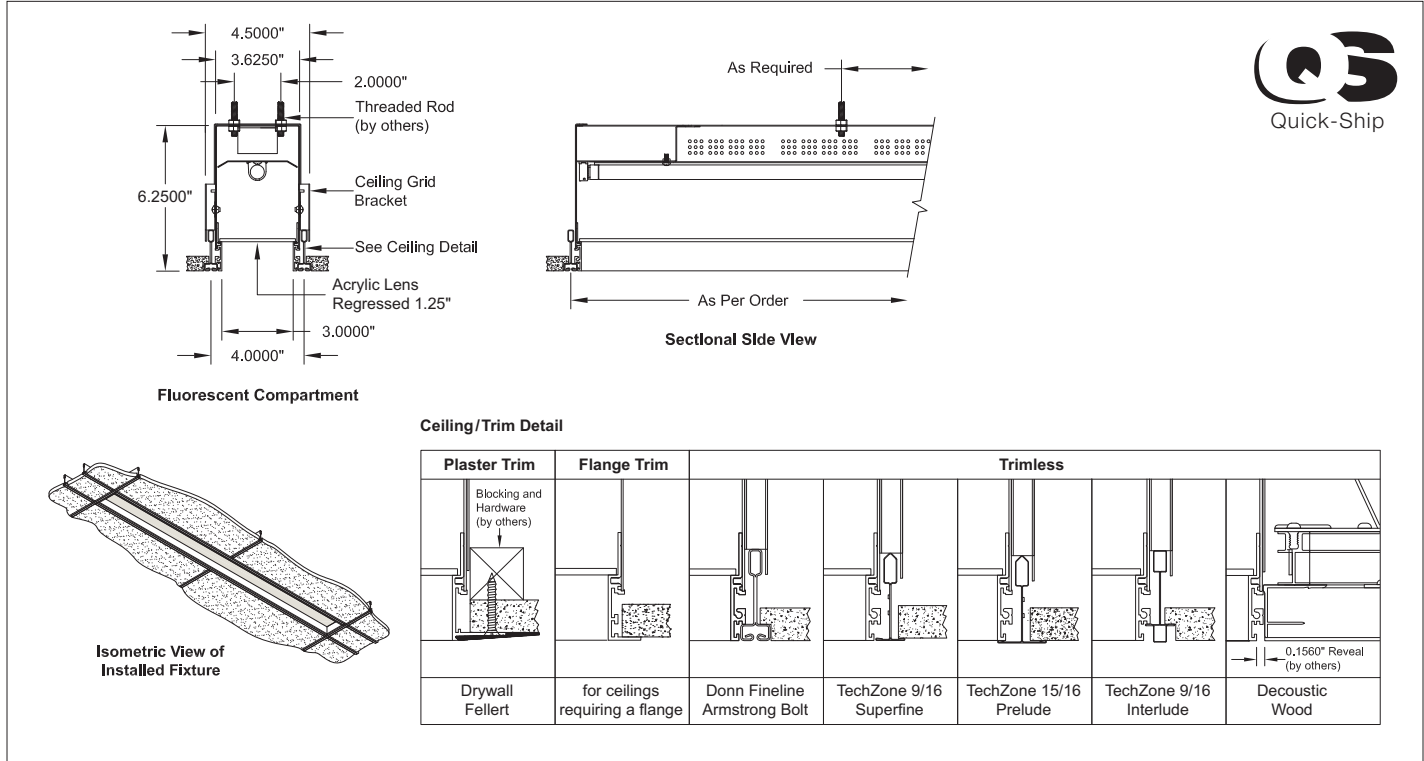

Any deviations from quick-ship options listed below will not be accepted

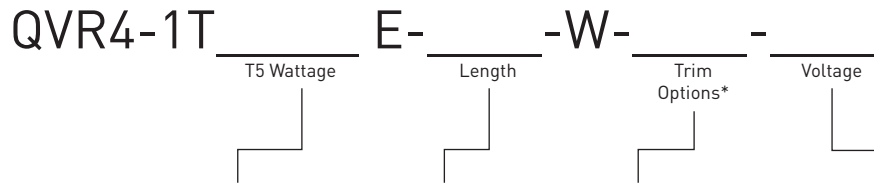

T5 Wattage	Length (Nominal)	Trim Options*	Voltage
<input type="checkbox"/> 28	<input type="checkbox"/> 48"	<input type="checkbox"/> P (Plaster Trim)	<input type="checkbox"/> 1 (120V)
<input type="checkbox"/> 54H0	<input type="checkbox"/> 96"	<input type="checkbox"/> F (Flange Trim)	<input type="checkbox"/> 2 (277V)
		<input type="checkbox"/> X (Trimless)	

\* **P=Plaster Trim:** For use with Drywall and Fellert.  
**F=Flange Trim:** For ceiling conditions requiring a flange.  
**X=Trimless:** For use with Donn Finline 9/16, Armstrong Bolt Slot 9/16, TechZone 9/16 Superfine, TechZone 15/16 Prelude, TechZone 9/16 Interlude, Decoustic and Wood.

### Quick-Ship Program

- Two week delivery from a clean release.
- Quantities limited to 50 units of each size per order.
- If order exceeds the product specification quantity the following would apply:  
If less than or equal to 2 times the Quick-Ship program maximum, the order will be split between two delivery dates.
- All Quick-Ship orders will be processed as separate purchase orders from non Quick-Ship orders.
- Quick-Ship Terms and Conditions, Page 4

### Fixture Description

Fluorescent slot with regressed lens.  
One T5 lamp in cross section.

### Fixture Features

- DuraFrost acrylic lens.
- Integral electronic ballast(s), thermally protected.
- Below ceiling access to ballast and wiring.

### Fixture Specifications

- Finish: White
- Weight: Approx. 6 lbs. per linear foot.
- Ceiling Cutout: Refer to Page 2

### Electrical

- Power Consumption: Per specification.
- Ambient temperature 100 °F. maximum.
- Through branch wiring capable.

### Mounting

- Threaded rod, hanger wire or alternate mounting by others, consult factory.

### Dimming

- Consult factory

Photometry: Page 3



All designs and scaled drawings shall remain the property of STARFIRE LIGHTING, INC., and may not be reproduced or transmitted without expressed written consent. STARFIRE LIGHTING, INC. reserves the right to make changes on approved designs to facilitate manufacturing methods to the extent that such changes do not compromise design integrity.

## QVR4

Job Name:

Fixture Type:

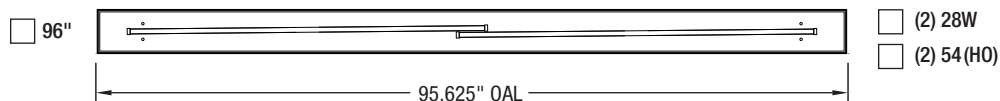
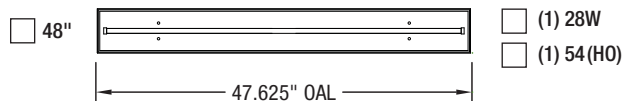

For fixture installation dimensions per trim type, follow formula below

Plaster Trim	<b>Furthest extent of tape-in flange</b> Length: OAL + 1.5", Width: 5.125"
	<b>Ceiling cut out</b> Length: OAL + 0.125", Width: 3.75"
Flange Trim	<b>Furthest extent of overlap flange</b> Length: OAL + 0.625", Width: 4.25"
	<b>Ceiling cut out</b> Length: OAL + 0.125", Width: 3.75"
Trimless	<b>Opening for Wood/Tile/Decoustic ceilings</b> Length: OAL + 0.125", Width: 3.75"
	<b>CTC Grid spacing for T-Grid/ATC systems</b> Length: OAL + 0.375", Width: 4"

Example: Trimless 48" (Nom) QVR4 in Decoustic ceiling  
 Length:  $47.625" + 0.125" = 47.75" \times 3.75"$  Wide

Starfire's patent pending EvenGlow™ system eliminates lamp/socket imaging and bright spots.

# QVR4 Fluorescent Slot, Regressed Lens

# Fixture Photometrics

Photometry reports for other fixture configurations, consult factory

## 1- T5 Lamp

28 Watt

DuraFrost Acrylic Lens

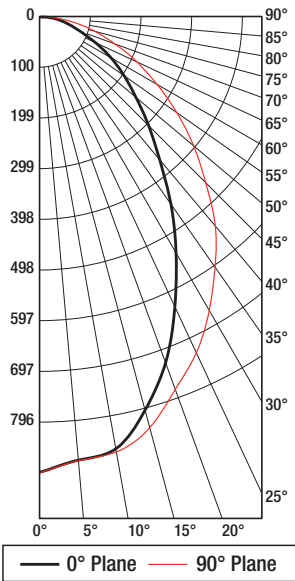
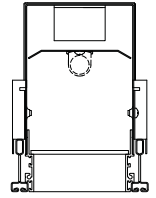

### Candela Distribution

	0	45	90
0	896	896	896
5	875	886	874
15	835	812	800
25	728	679	628
35	601	526	449
45	461	370	303
55	329	247	203
65	212	151	120
75	113	73	60
85	31	20	19
90	7	5	5

### Zonal Lumen Summary

	1.25	5
5	5	42
10	10	82
15	15	116
20	20	141
25	25	157
30	30	165
35	35	165
40	40	158
45	45	146
50	50	131
55	55	115
60	60	97
65	65	79
70	70	59
75	75	42
80	80	27
85	85	12
90	90	2

### Utilization

RC	80				70				50			30			10			Flux
RW	70	50	30	10	70	50	30	10	50	30	10	50	30	10	50	30	10	0
0	72	72	72	72	70	70	70	70	67	67	67	64	64	64	61	61	61	60
1	66	64	61	59	65	62	60	58	60	58	56	57	56	55	53	53	53	52
2	61	56	53	50	59	55	52	49	53	50	48	51	49	47	45	45	45	44
3	56	50	46	42	55	49	45	42	48	44	41	46	43	40	39	39	39	38
4	52	45	40	36	50	44	40	36	43	39	36	41	38	35	34	34	34	34
5	48	41	36	32	47	40	35	32	39	35	32	38	34	31	30	30	30	30
6	45	37	32	28	43	36	32	28	35	31	28	34	31	28	27	27	27	26
7	42	34	29	25	41	33	29	25	33	28	25	32	28	25	24	24	24	24
8	39	31	26	23	38	31	26	23	30	26	23	29	25	23	22	22	22	22
9	36	29	24	21	36	28	24	21	28	24	21	27	23	21	20	20	20	20
10	34	27	22	19	34	26	22	19	26	22	19	25	22	19	18	18	18	1

Total Luminaire Efficiency: 60.10%

# Terms and Conditions of Sale



**General:** Quick-Ship orders must be received by 12:00pm for same day order entry. Orders will shipped within 2 weeks of order processing. All orders are subject to acceptance by Starfire Lighting, Inc. in Wood-Ridge, New Jersey. Title to merchandise passes to the Purchaser upon lading to the carrier and such Title is not subject to any conditions set forth by the carrier with regard to payment of transportation charges and fees related to delivery at destination. All prices are subject to federal, state, and local taxes, if applicable, unless appropriate exemption certificate is on file at Starfire Lighting, Inc. in Wood-Ridge, New Jersey. All fixtures are sold without lamps unless otherwise specified.

**Force Majeure:** Under no circumstances shall Starfire Lighting, Inc. be liable for any delay or failure to perform hereunder when such failure or delay is, directly or indirectly, caused by, or in any manner arises from fire, floods, accidents, civil unrest, acts of God, war, governmental interference or embargoes, strikes, labor difficulties, shortage of labor, fuel, power, materials, or supplies, breakage of machinery or apparatus, transportation delays, or any other cause or causes (whether or not similar in nature to any of those hereinbefore specified) beyond its control.

**Payment Terms:** 1.5%-10 Days, Net 30 Days, subject to prior credit approval. All orders are subject to a minimum billing of \$250.00. Any past due amounts owed by Purchaser shall be subject to a service charge equal to 1.5% per month, but in no event higher than allowed by applicable law. In addition to such late payment, service charges, costs and expenses associated with collection of past due amounts, including reasonable attorney's fees, shall be added to amounts past due.

**Delivery:** Unless expressly agreed in writing to the contrary, the terms of delivery are F.O.B., Wood-Ridge, New Jersey. Purchaser bears the expense for shipping and risk of loss or damage for merchandise shipped hereunder. In case of loss or damage in transit, consignee must make all claims with delivering carrier within normal time limits established by the I.C.C. Consignee shall make immediate inspection of goods when received, and make prompt filing of claims (within 15 days from receipt of shipment). Air freight and overnight charges cannot be prepaid. If purchaser requires overnight or air shipments, please be prepared to receive material with freight charges to be collected at time of delivery, or furnish carrier account numbers. Purchaser is responsible for all re-delivery and re-consignment charges. Freight company fees and charges related to advanced notification of delivery shall be added to order invoices.

**Prices, Specifications, Variations, Errors:** Prices and specifications are subject to change without notice. In the event of a conflict between a customer's written order and Starfire Lighting, Inc. drawing or specification sheet marked "approved", the Starfire Lighting Inc. drawing or specification sheet shall prevail. Every effort is made to avoid errors in catalogs, specification sheets, and data references. Starfire Lighting, Inc. will not accept responsibility for labor charge-backs in connection with errors in typography, measurements and dimensioning, descriptions, omissions, etc. Orders containing such phrases as "all materials to be supplied as per project plans and specifications", etc. are subject to separate written acceptance by Starfire Lighting, Inc.

**Purchase Orders:** The acceptance of the buyer's Purchase Order(s) is contingent upon written acknowledgement by Starfire Lighting, Inc. The acceptance of the buyer's order is expressly made conditional on the buyer's assent to the terms and conditions stated herein. In the event of a conflict between the buyer's terms and conditions and Starfire Lighting's terms and conditions, buyer, in the absence of any written notification to the contrary and by virtue of issuance of purchase order and the acceptance of shipment of merchandise ordered, acknowledges that Starfire Lighting's Terms and Conditions of Sale shall take precedence and shall apply.

**Cancellations:** A 25% restocking charge will be applied to all canceled Quick-Ship orders.

**Returns Policy:** All sales are final. Merchandise to be returned under warranty shall be subject to the following conditions: No products will be accepted for return without prior written approval and unless accompanied by a properly authorized written "Return Goods Authorization", initiated by the appropriate Starfire Lighting, Inc. employee. Return freight must be prepaid. Merchandise being returned for repair under warranty shall be placed in transit to Starfire Lighting, Inc., 7 Donna Drive, Wood-Ridge, NJ within 30 days from the date of the written "Return Goods Authorization." Such request must show order number, our invoice number and date, and itemization of merchandise. All returns are subject to inspection.

**Warranties and Exclusive Remedy:** Starfire Lighting Inc. warrants its products (other than ballasts and emergency battery packs), when properly installed and under normal conditions of use, to be free from defects in material and workmanship at time of shipment. All warranty claims must be asserted within one year from the date of shipment of the subject items; thereafter warranty claims will not be honored. Purchaser's sole remedy for a warranty claim or otherwise shall be limited to repair or replacement of the subject product if it is shown to have been defective in material or workmanship at time of shipment. Starfire Lighting Inc.'s sole and maximum liability for a defective product shall not exceed the cost of the subject product. Except for such warranty and exclusive remedy as stated, (and the express warranty of title), we disclaim all other warranties, whether expressed or implied and specifically disclaim the implied warranties of merchantability and fitness for any particular purpose. In no event shall Starfire Lighting, Inc. be liable to Purchaser in warranty, contract negligence, strict liability or otherwise, for any damages, whether incidental or consequential which are alleged to be caused by one or more of Starfire Lighting, Inc.'s products, beyond the cost to the Purchaser of subject product or products. Therefore, the Purchaser's sole and exclusive remedy against Starfire Lighting, Inc. for breach of warranty, breach of contract or in negligence or in strict liability or otherwise shall be limited to repair or replacement of the subject product at our option (excluding installation and removal charges which shall not be Starfire Lighting, Inc.'s liability) or, refund of the purchase price. Warranty does not pass to the Purchaser until payment is received in full. In no case does the warranty and exclusive remedy extend to anyone other than the Purchaser. Purchaser is not authorized to extend warranties or remedies on Starfire Lighting, Inc.'s behalf to anyone. Such unauthorized extensions of warranties or remedies by the Purchaser shall remain the Purchaser's responsibility. Purchaser is responsible for determining the suitability of products for use or resale, or for incorporating them into objects or for application which Purchaser designs, assembles, constructs and manufactures.

Ballasts, emergency battery packs, lamps, and other such similar devices, may be covered by separate manufacturers' warranties. However Starfire Lighting, Inc. does not make any warranties whatsoever as to these items which are sold "AS IS," and Starfire Lighting, Inc. will accept no responsibility or liability whatsoever therefore.

**Transformer Noise:** Starfire Lighting, Inc. accepts no responsibility for transformer noise when used with dimmers or dimming systems.

**Changes In Specifications:** Starfire Lighting, Inc. reserves the right to make engineering or dimensional changes, without prior notification, to facilitate manufacturing methods; to the extent that such modifications do not compromise design integrity. Starfire Lighting, Inc. will not be obligated to modify fixtures manufactured prior to these changes.

**Fluorescent Slot, Regressed Lens**

T5

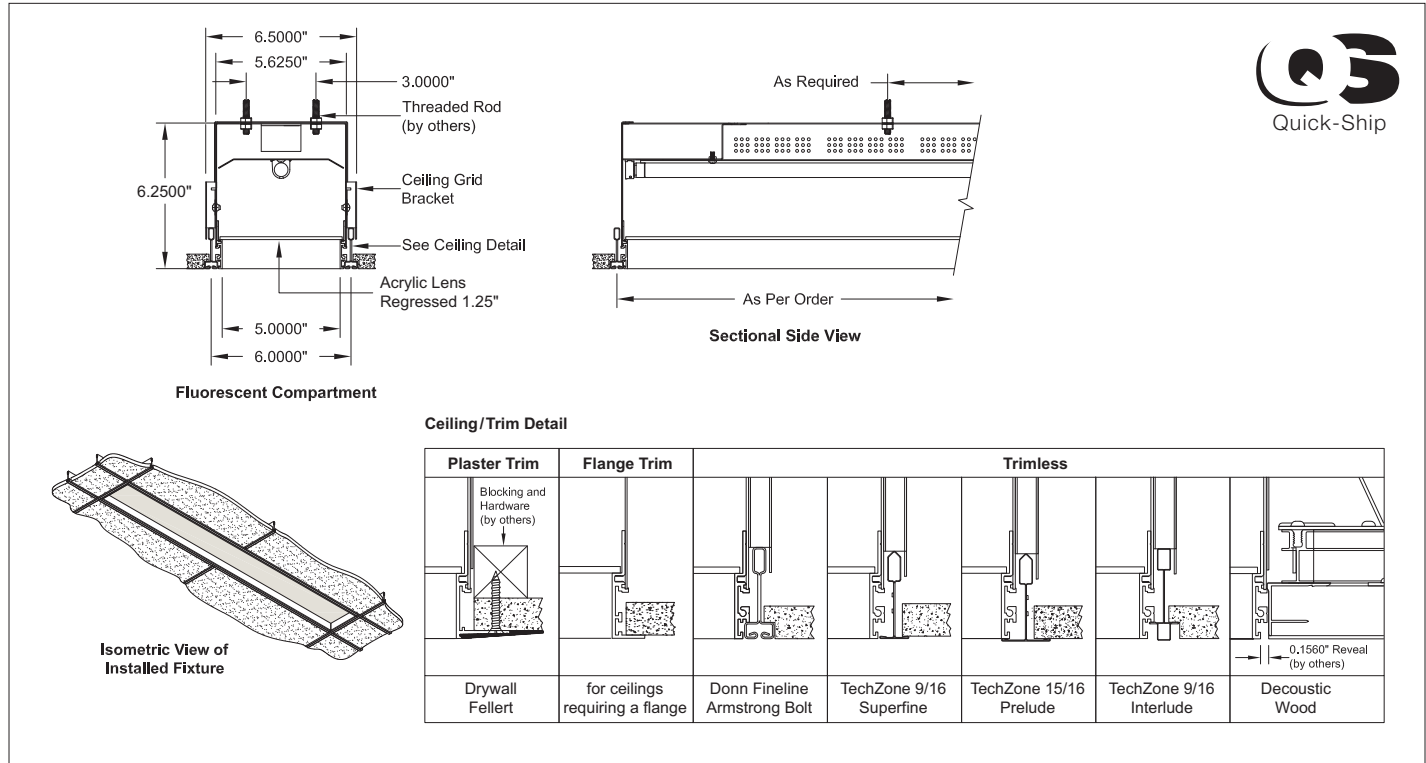

Any deviations from quick-ship options listed below will not be accepted

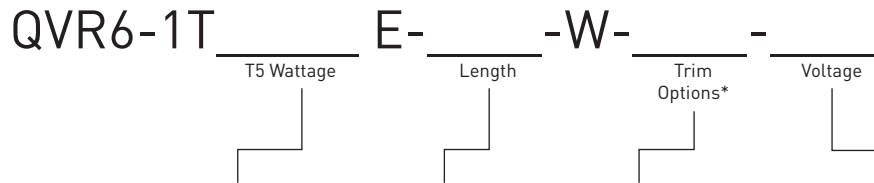

T5 Wattage	Length (Nominal)	Trim Options*	Voltage
<input type="checkbox"/> 28	<input type="checkbox"/> 48"	<input type="checkbox"/> P (Plaster Trim)	<input type="checkbox"/> 1 (120V)
<input type="checkbox"/> 54H0	<input type="checkbox"/> 96"	<input type="checkbox"/> F (Flange Trim)	<input type="checkbox"/> 2 (277V)
		<input type="checkbox"/> X (Trimless)	

\* P=Plaster Trim: For use with Drywall and Fellert.  
 F=Flange Trim: For ceiling conditions requiring a flange.  
 X=Trimless: For use with Donn Finline 9/16, Armstrong Bolt Slot 9/16, TechZone 9/16 Superfine, TechZone 15/16 Prelude, TechZone 9/16 Interlude, Decoustic and Wood.

**Quick-Ship Program**

- Two week delivery from a clean release.
- Quantities limited to 50 units of each size per order.
- If order exceeds the product specification quantity the following would apply: If less than or equal to 2 times the Quick-Ship program maximum, the order will be split between two delivery dates.
- All Quick-Ship orders will be processed as separate purchase orders from non Quick-Ship orders.
- Quick-Ship Terms and Conditions, Page 4

**Fixture Description**

Fluorescent slot with regressed lens. One T5 lamp in cross section.

**Fixture Features**

- DuraFrost acrylic lens.
- Integral electronic ballast(s), thermally protected.
- Below ceiling access to ballast and wiring.

**Fixture Specifications**

- Finish: White
- Weight: Approx. 7 lbs. per linear foot.
- Ceiling Cutout: Refer to Page 2

**Electrical**

- Power Consumption: Per specification.
- Ambient temperature 100 °F. maximum.
- Through branch wiring capable.

**Mounting**

- Threaded rod, hanger wire or alternate mounting by others, consult factory.

**Dimming**

- Consult factory

**Photometry:** Page 3



All designs and scaled drawings shall remain the property of STARFIRE LIGHTING, INC., and may not be reproduced or transmitted without expressed written consent. STARFIRE LIGHTING, INC. reserves the right to make changes on approved designs to facilitate manufacturing methods to the extent that such changes do not compromise design integrity.

## QVR6

Job Name:

Fixture Type:

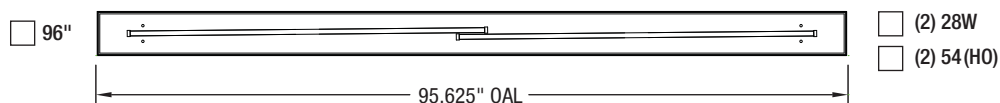
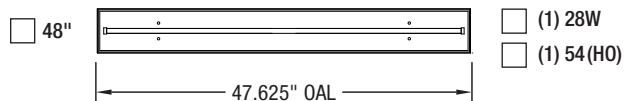

For fixture installation dimensions per trim type, follow formula below

Plaster Trim	<b>Furthest extent of tape-in flange</b> Length: OAL + 1.5", Width: 7.125"
	<b>Ceiling cut out</b> Length: OAL + 0.125", Width: 5.75"
Flange Trim	<b>Furthest extent of overlap flange</b> Length: OAL + 0.625", Width: 5.25"
	<b>Ceiling cut out</b> Length: OAL + 0.125", Width: 5.75"
Trimless	<b>Opening for Wood/Tile/Decoustic ceilings</b> Length: OAL + 0.125", Width: 5.75"
	<b>CTC Grid spacing for T-Grid/ATC systems</b> Length: OAL + 0.375", Width: 6"

Example: Trimless 48" (Nom) QVR6 in Decoustic ceiling  
 Length:  $47.625" + 0.125" = 47.75"$  x 5.75" Wide

Starfire's patent pending EvenGlow™ system eliminates lamp/socket imaging and bright spots.

# QVR6 Fluorescent Slot, Regressed Lens

# Fixture Photometrics

Photometry reports for other fixture configurations, consult factory

## 1- T5 Lamp

28 Watt

DuraFrost Acrylic Lens

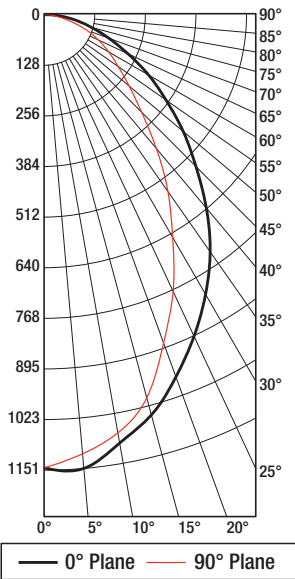
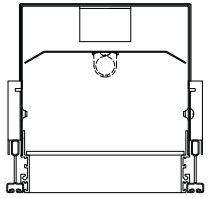

### Candela Distribution

	0	22.5	45	67.5	90
0	1145	1145	1145	1145	1145
5	1151	1118	1123	1123	1114
15	1047	1050	1036	1009	1003
25	897	893	839	789	772
35	732	703	634	565	546
45	543	511	436	371	348
55	376	344	282	237	229
65	234	206	170	156	151
75	124	109	92	78	75
85	40	30	23	20	21
90	10	8	6	5	5

### Zonal Lumen Summary

0-5	54
5-10	104
10-15	146
15-20	176
20-25	194
25-30	202
30-35	200
35-40	188
40-45	171
45-50	151
50-55	131
55-60	111
60-65	90
65-70	70
70-75	50
75-80	31
80-85	14
85-90	2

### Utilization

RC	80				70				50			30			10			Flux
RW	70	50	30	10	70	50	30	10	50	30	10	50	30	10	50	30	10	0
0	86	86	86	86	84	84	84	84	80	80	80	77	77	77	74	74	74	72
1	80	77	74	71	78	75	72	70	72	70	68	69	67	66	63	63	63	63
2	73	68	64	60	71	67	63	59	64	61	58	62	59	56	54	54	54	54
3	68	61	55	51	66	60	55	51	57	53	50	56	52	49	47	47	47	47
4	62	55	49	44	61	54	48	44	52	47	44	50	46	43	41	41	41	41
5	58	49	43	39	56	49	43	39	47	42	39	46	41	38	36	36	36	36
6	54	45	39	35	53	44	39	35	43	38	34	42	38	34	33	33	33	32
7	50	41	35	31	49	41	35	31	40	35	31	39	34	31	29	29	29	29
8	47	38	32	28	46	38	32	28	37	32	28	36	31	28	27	27	27	27
9	44	35	30	26	43	35	29	26	34	29	26	33	29	26	24	24	24	24
10	42	33	27	24	41	32	27	24	32	27	24	31	27	24	22	22	22	2

Total Luminaire Efficiency: 72.10%

# Terms and Conditions of Sale



**General:** Quick-Ship orders must be received by 12:00pm for same day order entry. Orders will shipped within 2 weeks of order processing. All orders are subject to acceptance by Starfire Lighting, Inc. in Wood-Ridge, New Jersey. Title to merchandise passes to the Purchaser upon lading to the carrier and such Title is not subject to any conditions set forth by the carrier with regard to payment of transportation charges and fees related to delivery at destination. All prices are subject to federal, state, and local taxes, if applicable, unless appropriate exemption certificate is on file at Starfire Lighting, Inc. in Wood-Ridge, New Jersey. All fixtures are sold without lamps unless otherwise specified.

**Force Majeure:** Under no circumstances shall Starfire Lighting, Inc. be liable for any delay or failure to perform hereunder when such failure or delay is, directly or indirectly, caused by, or in any manner arises from fire, floods, accidents, civil unrest, acts of God, war, governmental interference or embargoes, strikes, labor difficulties, shortage of labor, fuel, power, materials, or supplies, breakage of machinery or apparatus, transportation delays, or any other cause or causes (whether or not similar in nature to any of those hereinbefore specified) beyond its control.

**Payment Terms:** 1.5%-10 Days, Net 30 Days, subject to prior credit approval. All orders are subject to a minimum billing of \$250.00. Any past due amounts owed by Purchaser shall be subject to a service charge equal to 1.5% per month, but in no event higher than allowed by applicable law. In addition to such late payment, service charges, costs and expenses associated with collection of past due amounts, including reasonable attorney's fees, shall be added to amounts past due.

**Delivery:** Unless expressly agreed in writing to the contrary, the terms of delivery are F.O.B., Wood-Ridge, New Jersey. Purchaser bears the expense for shipping and risk of loss or damage for merchandise shipped hereunder. In case of loss or damage in transit, consignee must make all claims with delivering carrier within normal time limits established by the I.C.C. Consignee shall make immediate inspection of goods when received, and make prompt filing of claims (within 15 days from receipt of shipment). Air freight and overnight charges cannot be prepaid. If purchaser requires overnight or air shipments, please be prepared to receive material with freight charges to be collected at time of delivery, or furnish carrier account numbers. Purchaser is responsible for all re-delivery and re-consignment charges. Freight company fees and charges related to advanced notification of delivery shall be added to order invoices.

**Prices, Specifications, Variations, Errors:** Prices and specifications are subject to change without notice. In the event of a conflict between a customer's written order and Starfire Lighting, Inc. drawing or specification sheet marked "approved", the Starfire Lighting Inc. drawing or specification sheet shall prevail. Every effort is made to avoid errors in catalogs, specification sheets, and data references. Starfire Lighting, Inc. will not accept responsibility for labor charge-backs in connection with errors in typography, measurements and dimensioning, descriptions, omissions, etc. Orders containing such phrases as "all materials to be supplied as per project plans and specifications", etc. are subject to separate written acceptance by Starfire Lighting, Inc.

**Purchase Orders:** The acceptance of the buyer's Purchase Order(s) is contingent upon written acknowledgement by Starfire Lighting, Inc. The acceptance of the buyer's order is expressly made conditional on the buyer's assent to the terms and conditions stated herein. In the event of a conflict between the buyer's terms and conditions and Starfire Lighting's terms and conditions, buyer, in the absence of any written notification to the contrary and by virtue of issuance of purchase order and the acceptance of shipment of merchandise ordered, acknowledges that Starfire Lighting's Terms and Conditions of Sale shall take precedence and shall apply.

**Cancellations:** A 25% restocking charge will be applied to all canceled Quick-Ship orders.

**Returns Policy:** All sales are final. Merchandise to be returned under warranty shall be subject to the following conditions: No products will be accepted for return without prior written approval and unless accompanied by a properly authorized written "Return Goods Authorization", initiated by the appropriate Starfire Lighting, Inc. employee. Return freight must be prepaid. Merchandise being returned for repair under warranty shall be placed in transit to Starfire Lighting, Inc., 7 Donna Drive, Wood-Ridge, NJ within 30 days from the date of the written "Return Goods Authorization." Such request must show order number, our invoice number and date, and itemization of merchandise. All returns are subject to inspection.

**Warranties and Exclusive Remedy:** Starfire Lighting Inc. warrants its products (other than ballasts and emergency battery packs), when properly installed and under normal conditions of use, to be free from defects in material and workmanship at time of shipment. All warranty claims must be asserted within one year from the date of shipment of the subject items; thereafter warranty claims will not be honored. Purchaser's sole remedy for a warranty claim or otherwise shall be limited to repair or replacement of the subject product if it is shown to have been defective in material or workmanship at time of shipment. Starfire Lighting Inc.'s sole and maximum liability for a defective product shall not exceed the cost of the subject product. Except for such warranty and exclusive remedy as stated, (and the express warranty of title), we disclaim all other warranties, whether expressed or implied and specifically disclaim the implied warranties of merchantability and fitness for any particular purpose. In no event shall Starfire Lighting, Inc. be liable to Purchaser in warranty, contract negligence, strict liability or otherwise, for any damages, whether incidental or consequential which are alleged to be caused by one or more of Starfire Lighting, Inc.'s products, beyond the cost to the Purchaser of subject product or products. Therefore, the Purchaser's sole and exclusive remedy against Starfire Lighting, Inc. for breach of warranty, breach of contract or in negligence or in strict liability or otherwise shall be limited to repair or replacement of the subject product at our option (excluding installation and removal charges which shall not be Starfire Lighting, Inc.'s liability) or, refund of the purchase price. Warranty does not pass to the Purchaser until payment is received in full. In no case does the warranty and exclusive remedy extend to anyone other than the Purchaser. Purchaser is not authorized to extend warranties or remedies on Starfire Lighting, Inc.'s behalf to anyone. Such unauthorized extensions of warranties or remedies by the Purchaser shall remain the Purchaser's responsibility. Purchaser is responsible for determining the suitability of products for use or resale, or for incorporating them into objects or for application which Purchaser designs, assembles, constructs and manufactures.

Ballasts, emergency battery packs, lamps, and other such similar devices, may be covered by separate manufacturers' warranties. However Starfire Lighting, Inc. does not make any warranties whatsoever as to these items which are sold "AS IS," and Starfire Lighting, Inc. will accept no responsibility or liability whatsoever therefore.

**Transformer Noise:** Starfire Lighting, Inc. accepts no responsibility for transformer noise when used with dimmers or dimming systems.

**Changes In Specifications:** Starfire Lighting, Inc. reserves the right to make engineering or dimensional changes, without prior notification, to facilitate manufacturing methods; to the extent that such modifications do not compromise design integrity. Starfire Lighting, Inc. will not be obligated to modify fixtures manufactured prior to these changes.



**Fluorescent Slot, Flush Lens**

T5

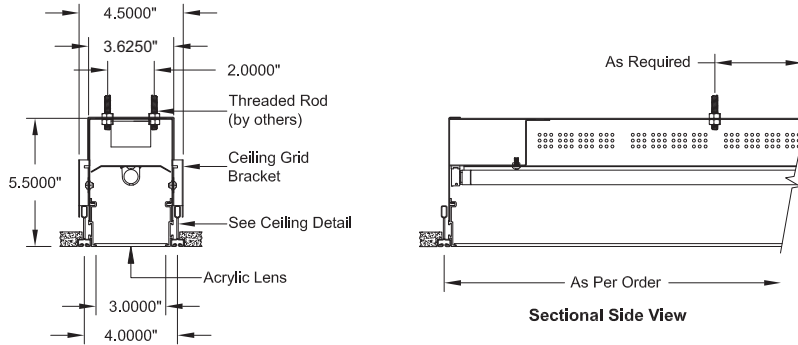

Fluorescent Compartment

Ceiling/Trim Detail

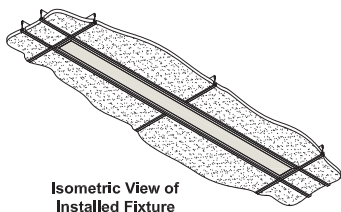

Isometric View of Installed Fixture

Plaster Trim	Flange Trim	Trimless				
Drywall Fellert	for ceilings requiring a flange	Donn Fineline Armstrong Bolt	TechZone 9/16 Superfine	TechZone 15/16 Prelude	TechZone 9/16 Interlude	Decoustic Wood 0,1560" Reveal (by others)

Any deviations from quick-ship options listed below will not be accepted

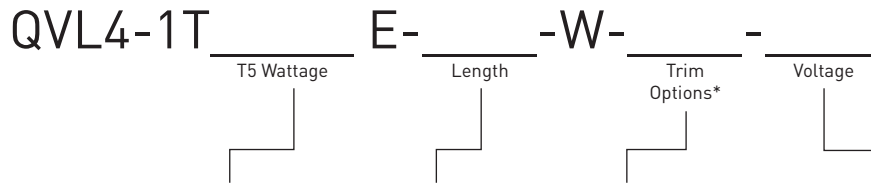

T5 Wattage	Length (Nominal)	Trim Options*	Voltage
<input type="checkbox"/> 28	<input type="checkbox"/> 48"	<input type="checkbox"/> P (Plaster Trim)	<input type="checkbox"/> 1 (120V)
<input type="checkbox"/> 54H0	<input type="checkbox"/> 96"	<input type="checkbox"/> F (Flange Trim)	<input type="checkbox"/> 2 (277V)
		<input type="checkbox"/> X (Trimless)	

\* P=Plaster Trim: For use with Drywall and Fellert.  
 F=Flange Trim: For ceiling conditions requiring a flange.  
 X=Trimless: For use with Donn Fineline 9/16, Armstrong Bolt Slot 9/16, TechZone 9/16 Superfine, TechZone 15/16 Prelude, TechZone 9/16 Interlude, Decoustic and Wood.

**Quick-Ship Program**

- Two week delivery from a clean release.
- Quantities limited to 50 units of each size per order.
- If order exceeds the product specification quantity the following would apply:  
 If less than or equal to 2 times the Quick-Ship program maximum, the order will be split between two delivery dates.
- All Quick-Ship orders will be processed as separate purchase orders from non Quick-Ship orders.
- Quick-Ship Terms and Conditions, Page 4

**Fixture Description**

Fluorescent slot with flush lens.  
 One T5 lamp in cross section.

**Fixture Features**

- Rabbeted DuraFrost acrylic lens.
- Integral electronic ballast(s), thermally protected.
- Below ceiling access to ballast and wiring.

**Fixture Specifications**

- Finish: White
- Weight: Approx. 6 lbs. per linear foot.
- Ceiling Cutout: Refer to Page 2

**Electrical**

- Power Consumption: Per specification.
- Ambient temperature 100 °F. maximum.
- Through branch wiring capable.

**Mounting**

- Threaded rod, hanger wire or alternate mounting by others, consult factory.

**Dimming**

- Consult factory

**Photometry: Page 3**



## QVL4

Job Name:

Fixture Type:

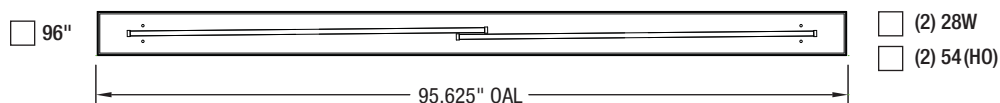
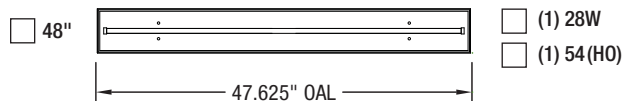

For fixture installation dimensions per trim type, follow formula below

Plaster Trim	<b>Furthest extent of tape-in flange</b> Length: OAL + 1.6875", Width: 5.3125"
	<b>Ceiling cut out</b> Length: OAL + 0.125", Width: 3.75"
Flange Trim	<b>Furthest extent of overlap flange</b> Length: OAL + 0.5625", Width: 4.1875"
	<b>Ceiling cut out</b> Length: OAL + 0.125", Width: 3.75"
Trimless	<b>Opening for Wood/Tile/Decoustic ceilings</b> Length: OAL + 0.125", Width: 3.75"
	<b>CTC Grid spacing for T-Grid/ATC systems</b> Length: OAL + 0.375", Width: 4"

Example: Trimless 48" (Nom) QVL4 in Decoustic ceiling  
 Length: 47.625" + 0.125" = 47.75" x 3.75" Wide

Starfire's patent pending EvenGlow™ system eliminates lamp/socket imaging and bright spots.

# QVL4 Fluorescent Slot, Flush Lens

# Fixture Photometrics

Photometry reports for other fixture configurations, consult factory

## 1- T5 Lamp

28 Watt

DuraFrost Acrylic Lens

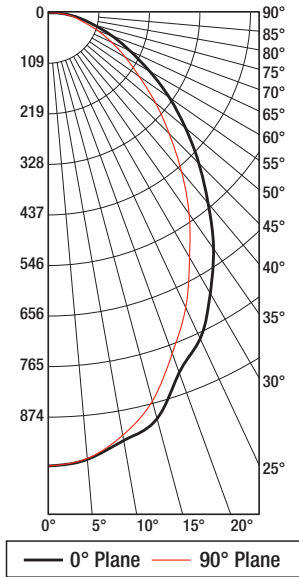
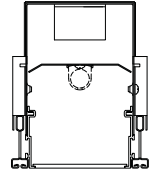

### Candela Distribution

	0	22.5	45	67.5	90
0	979	979	979	979	979
5	969	970	966	983	967
15	909	895	885	882	869
25	777	764	736	717	703
35	623	610	569	537	531
45	461	448	406	378	370
55	319	303	277	252	240
65	195	185	168	154	151
75	103	99	89	84	80
85	40	35	33	32	34
90	9	7	6	5	6

### Zonal Lumen Summary

0-5	46
5-10	89
10-15	126
15-20	152
20-25	171
25-30	180
30-35	180
35-40	173
40-45	160
45-50	143
50-55	125
55-60	105
60-65	85
65-70	66
70-75	48
75-80	34
80-85	19
85-90	2

### Utilization

RC	80				70				50			30			10			Flux
	70	50	30	10	70	50	30	10	50	30	10	50	30	10	50	30	10	
0	79	79	79	79	77	77	77	77	73	73	73	70	70	70	67	67	67	66
1	73	70	67	65	71	68	66	64	65	63	62	63	61	60	57	57	57	57
2	67	62	57	54	65	60	57	53	58	55	52	56	53	51	49	49	49	48
3	61	55	50	46	60	54	49	46	52	48	45	50	47	44	42	42	42	42
4	57	49	44	40	55	48	43	40	47	42	39	45	42	39	37	37	37	37
5	52	45	39	35	51	44	39	35	42	38	34	41	37	34	32	32	32	32
6	49	41	35	31	48	40	35	31	39	34	31	38	34	30	29	29	29	29
7	45	37	32	28	44	37	31	28	36	31	28	35	30	27	26	26	26	26
8	43	34	29	25	42	34	29	25	33	28	25	32	28	25	24	24	24	23
9	40	32	26	23	39	31	26	23	30	26	23	30	26	23	21	21	21	21
10	38	29	24	21	37	29	24	21	28	24	21	28	24	21	20	20	20	2

Total Luminaire Efficiency: 65.80%

# Terms and Conditions of Sale



**General:** Quick-Ship Purchase Orders must be faxed to Starfire Lighting at 201-438-9541 or emailed: info@starfirelighting.com. Quick-Ship orders must be received by 12:00pm for same day order entry. Orders will shipped within 2 weeks of order processing. All orders are subject to acceptance by Starfire Lighting, Inc. in Wood-Ridge, New Jersey. Title to merchandise passes to the Purchaser upon lading to the carrier and such Title is not subject to any conditions set forth by the carrier with regard to payment of transportation charges and fees related to delivery at destination. All prices are subject to federal, state, and local taxes, if applicable, unless appropriate exemption certificate is on file at Starfire Lighting, Inc. in Wood-Ridge, New Jersey. All fixtures are sold without lamps unless otherwise specified.

**Force Majeure:** Under no circumstances shall Starfire Lighting, Inc. be liable for any delay or failure to perform hereunder when such failure or delay is, directly or indirectly, caused by, or in any manner arises from fire, floods, accidents, civil unrest, acts of God, war, governmental interference or embargoes, strikes, labor difficulties, shortage of labor, fuel, power, materials, or supplies, breakage of machinery or apparatus, transportation delays, or any other cause or causes (whether or not similar in nature to any of those hereinbefore specified) beyond its control.

**Payment Terms:** 1.5%-10 Days, Net 30 Days, subject to prior credit approval. All orders are subject to a minimum billing of \$250.00. Any past due amounts owed by Purchaser shall be subject to a service charge equal to 1.5% per month, but in no event higher than allowed by applicable law. In addition to such late payment, service charges, costs and expenses associated with collection of past due amounts, including reasonable attorney's fees, shall be added to amounts past due.

**Delivery:** Unless expressly agreed in writing to the contrary, the terms of delivery are F.O.B., Wood-Ridge, New Jersey. Purchaser bears the expense for shipping and risk of loss or damage for merchandise shipped hereunder. In case of loss or damage in transit, consignee must make all claims with delivering carrier within normal time limits established by the I.C.C. Consignee shall make immediate inspection of goods when received, and make prompt filing of claims (within 15 days from receipt of shipment). Air freight and overnight charges cannot be prepaid. If purchaser requires overnight or air shipments, please be prepared to receive material with freight charges to be collected at time of delivery, or furnish carrier account numbers. Purchaser is responsible for all re-delivery and re-consignment charges. Freight company fees and charges related to advanced notification of delivery shall be added to order invoices.

**Prices, Specifications, Variations, Errors:** Prices and specifications are subject to change without notice. In the event of a conflict between a customer's written order and Starfire Lighting, Inc. drawing or specification sheet marked "approved", the Starfire Lighting Inc. drawing or specification sheet shall prevail. Every effort is made to avoid errors in catalogs, specification sheets, and data references. Starfire Lighting, Inc. will not accept responsibility for labor charge-backs in connection with errors in typography, measurements and dimensioning, descriptions, omissions, etc. Orders containing such phrases as "all materials to be supplied as per project plans and specifications", etc. are subject to separate written acceptance by Starfire Lighting, Inc.

**Purchase Orders:** The acceptance of the buyer's Purchase Order(s) is contingent upon written acknowledgement by Starfire Lighting, Inc. The acceptance of the buyer's order is expressly made conditional on the buyer's assent to the terms and conditions stated herein. In the event of a conflict between the buyer's terms and conditions and Starfire Lighting's terms and conditions, buyer, in the absence of any written notification to the contrary and by virtue of issuance of purchase order and the acceptance of shipment of merchandise ordered, acknowledges that Starfire Lighting's Terms and Conditions of Sale shall take precedence and shall apply.

**Cancellations:** A 25% restocking charge will be applied to all canceled Quick-Ship orders.

**Returns Policy:** All sales are final. Merchandise to be returned under warranty shall be subject to the following conditions: No products will be accepted for return without prior written approval and unless accompanied by a properly authorized written "Return Goods Authorization", initiated by the appropriate Starfire Lighting, Inc. employee. Return freight must be prepaid. Merchandise being returned for repair under warranty shall be placed in transit to Starfire Lighting, Inc., 7 Donna Drive, Wood-Ridge, NJ within 30 days from the date of the written "Return Goods Authorization." Such request must show order number, our invoice number and date, and itemization of merchandise. All returns are subject to inspection.

**Warranties and Exclusive Remedy:** Starfire Lighting Inc. warrants its products (other than ballasts and emergency battery packs), when properly installed and under normal conditions of use, to be free from defects in material and workmanship at time of shipment. All warranty claims must be asserted within one year from the date of shipment of the subject items; thereafter warranty claims will not be honored. Purchaser's sole remedy for a warranty claim or otherwise shall be limited to repair or replacement of the subject product if it is shown to have been defective in material or workmanship at time of shipment. Starfire Lighting Inc.'s sole and maximum liability for a defective product shall not exceed the cost of the subject product. Except for such warranty and exclusive remedy as stated, (and the express warranty of title), we disclaim all other warranties, whether expressed or implied and specifically disclaim the implied warranties of merchantability and fitness for any particular purpose. In no event shall Starfire Lighting, Inc. be liable to Purchaser in warranty, contract negligence, strict liability or otherwise, for any damages, whether incidental or consequential which are alleged to be caused by one or more of Starfire Lighting, Inc.'s products, beyond the cost to the Purchaser of subject product or products. Therefore, the Purchaser's sole and exclusive remedy against Starfire Lighting, Inc. for breach of warranty, breach of contract or in negligence or in strict liability or otherwise shall be limited to repair or replacement of the subject product at our option (excluding installation and removal charges which shall not be Starfire Lighting, Inc.'s liability) or, refund of the purchase price. Warranty does not pass to the Purchaser until payment is received in full. In no case does the warranty and exclusive remedy extend to anyone other than the Purchaser. Purchaser is not authorized to extend warranties or remedies on Starfire Lighting, Inc.'s behalf to anyone. Such unauthorized extensions of warranties or remedies by the Purchaser shall remain the Purchaser's responsibility. Purchaser is responsible for determining the suitability of products for use or resale, or for incorporating them into objects or for application which Purchaser designs, assembles, constructs and manufactures.

Ballasts, emergency battery packs, lamps, and other such similar devices, may be covered by separate manufacturers' warranties. However Starfire Lighting, Inc. does not make any warranties whatsoever as to these items which are sold "AS IS," and Starfire Lighting, Inc. will accept no responsibility or liability whatsoever therefore.

**Transformer Noise:** Starfire Lighting, Inc. accepts no responsibility for transformer noise when used with dimmers or dimming systems.

**Changes In Specifications:** Starfire Lighting, Inc. reserves the right to make engineering or dimensional changes, without prior notification, to facilitate manufacturing methods; to the extent that such modifications do not compromise design integrity. Starfire Lighting, Inc. will not be obligated to modify fixtures manufactured prior to these changes.

**Fluorescent Slot, Flush Lens**

T5

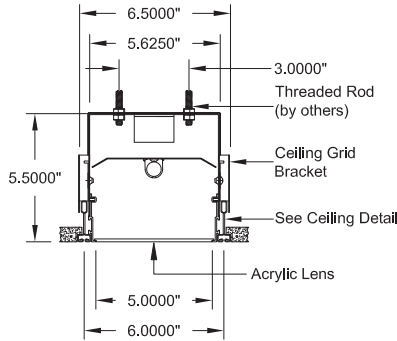

Fluorescent Compartment

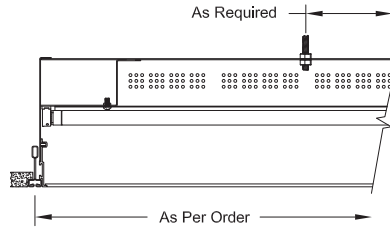

Sectional Side View

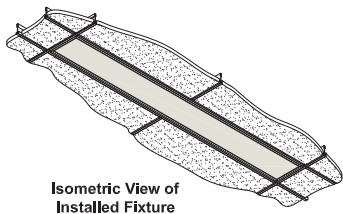

Isometric View of Installed Fixture

Ceiling/Trim Detail

Plaster Trim	Flange Trim	Trimless				
Drywall Fellert	for ceilings requiring a flange	Donn Finline Armstrong Bolt	TechZone 9/16 Superfine	TechZone 15/16 Prelude	TechZone 9/16 Interlude	Decoustic Wood

Any deviations from quick-ship options listed below will not be accepted

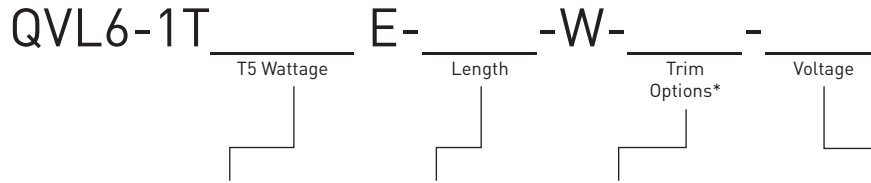

T5 Wattage	Length (Nominal)	Trim Options*	Voltage
<input type="checkbox"/> 28	<input type="checkbox"/> 48"	<input type="checkbox"/> P (Plaster Trim)	<input type="checkbox"/> 1 (120V)
<input type="checkbox"/> 54H0	<input type="checkbox"/> 96"	<input type="checkbox"/> F (Flange Trim)	<input type="checkbox"/> 2 (277V)
		<input type="checkbox"/> X (Trimless)	

\* P=Plaster Trim: For use with Drywall and Fellert.  
 F=Flange Trim: For ceiling conditions requiring a flange.  
 X=Trimless: For use with Donn Finline 9/16, Armstrong Bolt Slot 9/16, TechZone 9/16 Superfine, TechZone 15/16 Prelude, TechZone 9/16 Interlude, Decoustic and Wood.

**Quick-Ship Program**

- Two week delivery from a clean release.
- Quantities limited to 50 units of each size per order.
- If order exceeds the product specification quantity the following would apply: If less than or equal to 2 times the Quick-Ship program maximum, the order will be split between two delivery dates.
- All Quick-Ship orders will be processed as separate purchase orders from non Quick-Ship orders.
- Quick-Ship Terms and Conditions, Page 4

**Fixture Description**

Fluorescent slot with flush lens. One T5 lamp in cross section.

**Fixture Features**

- Rabbeted DuraFrost acrylic lens.
- Integral electronic ballast(s), thermally protected.
- Below ceiling access to ballast and wiring.

**Fixture Specifications**

- Finish: White
- Weight: Approx. 7 lbs. per linear foot.
- Ceiling Cutout: Refer to Page 2

**Electrical**

- Power Consumption: Per specification.
- Ambient temperature 100 °F. maximum.
- Through branch wiring capable.

**Mounting**

- Threaded rod, hanger wire or alternate mounting by others, consult factory.

**Dimming**

- Consult factory

Photometry: Page 3



All designs and scaled drawings shall remain the property of STARFIRE LIGHTING, INC., and may not be reproduced or transmitted without expressed written consent. STARFIRE LIGHTING, INC. reserves the right to make changes on approved designs to facilitate manufacturing methods to the extent that such changes do not compromise design integrity.

## QVL6

Job Name: \_\_\_\_\_ Fixture Type: \_\_\_\_\_

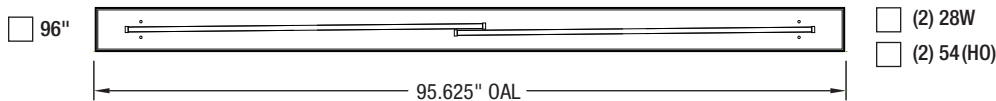
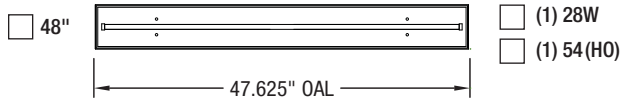

For fixture installation dimensions per trim type, follow formula below

Plaster Trim	<b>Furthest extent of tape-in flange</b> Length: OAL + 1.6875", Width: 7.3125"
	<b>Ceiling cut out</b> Length: OAL + 0.125", Width: 5.75"
Flange Trim	<b>Furthest extent of overlap flange</b> Length: OAL + 0.5625", Width: 6.1875"
	<b>Ceiling cut out</b> Length: OAL + 0.125", Width: 5.75"
Trimless	<b>Opening for Wood/Tile/Decoustic ceilings</b> Length: OAL + 0.125", Width: 5.75"
	<b>CTC Grid spacing for T-Grid/ATC systems</b> Length: OAL + 0.375", Width: 6"

Example: Trimless 48" (Nom) QVL6 in Decoustic ceiling  
 Length: 47.625" + 0.125" = 47.75" x 5.75" Wide

Starfire's patent pending EvenGlow™ system eliminates lamp/socket imaging and bright spots.

# QVL6 Fluorescent Slot, Flush Lens

# Fixture Photometrics

Photometry reports for other fixture configurations, consult factory

## 1- T5 Lamp

28 Watt

DuraFrost Acrylic Lens

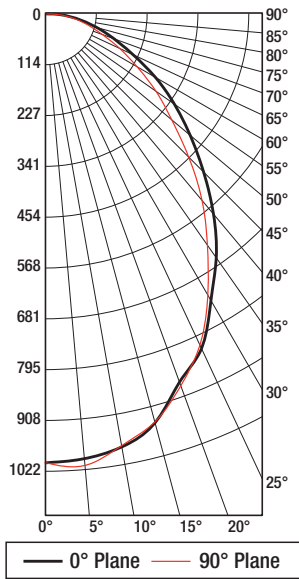

### Candela Distribution

	0	22.5	45	67.5	90
0	1002	1002	1002	1002	1002
5	997	1022	1014	1005	1013
15	946	944	951	939	944
25	825	813	822	819	816
35	665	661	662	640	631
45	500	500	483	466	453
55	351	344	325	306	301
65	216	214	202	188	183
75	120	116	108	100	100
85	46	43	41	38	40
90	11	9	8	7	7

### Zonal Lumen Summary

0-5	48
5-10	94
10-15	134
15-20	166
20-25	190
25-30	203
30-35	205
35-40	199
40-45	187
45-50	168
50-55	146
55-60	124
60-65	100
65-70	77
70-75	57
75-80	41
80-85	23
85-90	2

### Utilization

RC	80				70				50			30			10			Flux
RW	70	50	30	10	70	50	30	10	50	30	10	50	30	10	50	30	10	0
0	89	89	89	89	87	87	87	87	83	83	83	80	80	80	77	77	77	75
1	82	79	76	73	80	77	74	72	74	72	70	71	69	68	65	65	65	64
2	75	70	65	61	73	68	64	60	66	62	59	63	60	57	55	55	55	55
3	69	62	56	52	67	61	55	51	59	54	50	56	53	49	47	47	47	47
4	64	55	49	45	62	54	49	44	53	48	44	51	47	43	41	41	41	41
5	59	50	44	39	58	49	43	39	48	42	38	46	42	38	36	36	36	36
6	55	45	39	34	53	45	39	34	43	38	34	42	37	34	32	32	32	32
7	51	41	35	31	50	41	35	31	40	34	30	39	34	30	29	29	29	29
8	48	38	32	28	47	38	32	28	37	31	28	36	31	27	26	26	26	26
9	45	35	29	25	44	35	29	25	34	29	25	33	28	25	24	24	24	23
10	42	33	27	23	41	32	27	23	31	26	23	31	26	23	22	22	22	2

Total Luminaire Efficiency: 74.80%

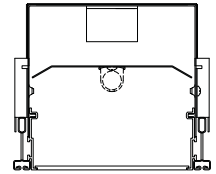

# Terms and Conditions of Sale



**General:** Quick-Ship Purchase Orders must be faxed to Starfire Lighting at 201-438-9541 or emailed: info@starfirelighting.com. Quick-Ship orders must be received by 12:00pm for same day order entry. Orders will shipped within 2 weeks of order processing. All orders are subject to acceptance by Starfire Lighting, Inc. in Wood-Ridge, New Jersey. Title to merchandise passes to the Purchaser upon lading to the carrier and such Title is not subject to any conditions set forth by the carrier with regard to payment of transportation charges and fees related to delivery at destination. All prices are subject to federal, state, and local taxes, if applicable, unless appropriate exemption certificate is on file at Starfire Lighting, Inc. in Wood-Ridge, New Jersey. All fixtures are sold without lamps unless otherwise specified.

**Force Majeure:** Under no circumstances shall Starfire Lighting, Inc. be liable for any delay or failure to perform hereunder when such failure or delay is, directly or indirectly, caused by, or in any manner arises from fire, floods, accidents, civil unrest, acts of God, war, governmental interference or embargoes, strikes, labor difficulties, shortage of labor, fuel, power, materials, or supplies, breakage of machinery or apparatus, transportation delays, or any other cause or causes (whether or not similar in nature to any of those hereinbefore specified) beyond its control.

**Payment Terms:** 1.5%-10 Days, Net 30 Days, subject to prior credit approval. All orders are subject to a minimum billing of \$250.00. Any past due amounts owed by Purchaser shall be subject to a service charge equal to 1.5% per month, but in no event higher than allowed by applicable law. In addition to such late payment, service charges, costs and expenses associated with collection of past due amounts, including reasonable attorney's fees, shall be added to amounts past due.

**Delivery:** Unless expressly agreed in writing to the contrary, the terms of delivery are F.O.B., Wood-Ridge, New Jersey. Purchaser bears the expense for shipping and risk of loss or damage for merchandise shipped hereunder. In case of loss or damage in transit, consignee must make all claims with delivering carrier within normal time limits established by the I.C.C. Consignee shall make immediate inspection of goods when received, and make prompt filing of claims (within 15 days from receipt of shipment). Air freight and overnight charges cannot be prepaid. If purchaser requires overnight or air shipments, please be prepared to receive material with freight charges to be collected at time of delivery, or furnish carrier account numbers. Purchaser is responsible for all re-delivery and re-consignment charges. Freight company fees and charges related to advanced notification of delivery shall be added to order invoices.

**Prices, Specifications, Variations, Errors:** Prices and specifications are subject to change without notice. In the event of a conflict between a customer's written order and Starfire Lighting, Inc. drawing or specification sheet marked "approved", the Starfire Lighting Inc. drawing or specification sheet shall prevail. Every effort is made to avoid errors in catalogs, specification sheets, and data references. Starfire Lighting, Inc. will not accept responsibility for labor charge-backs in connection with errors in typography, measurements and dimensioning, descriptions, omissions, etc. Orders containing such phrases as "all materials to be supplied as per project plans and specifications", etc. are subject to separate written acceptance by Starfire Lighting, Inc.

**Purchase Orders:** The acceptance of the buyer's Purchase Order(s) is contingent upon written acknowledgement by Starfire Lighting, Inc. The acceptance of the buyer's order is expressly made conditional on the buyer's assent to the terms and conditions stated herein. In the event of a conflict between the buyer's terms and conditions and Starfire Lighting's terms and conditions, buyer, in the absence of any written notification to the contrary and by virtue of issuance of purchase order and the acceptance of shipment of merchandise ordered, acknowledges that Starfire Lighting's Terms and Conditions of Sale shall take precedence and shall apply.

**Cancellations:** A 25% restocking charge will be applied to all canceled Quick-Ship orders.

**Returns Policy:** All sales are final. Merchandise to be returned under warranty shall be subject to the following conditions: No products will be accepted for return without prior written approval and unless accompanied by a properly authorized written "Return Goods Authorization", initiated by the appropriate Starfire Lighting, Inc. employee. Return freight must be prepaid. Merchandise being returned for repair under warranty shall be placed in transit to Starfire Lighting, Inc., 7 Donna Drive, Wood-Ridge, NJ within 30 days from the date of the written "Return Goods Authorization." Such request must show order number, our invoice number and date, and itemization of merchandise. All returns are subject to inspection.

**Warranties and Exclusive Remedy:** Starfire Lighting Inc. warrants its products (other than ballasts and emergency battery packs), when properly installed and under normal conditions of use, to be free from defects in material and workmanship at time of shipment. All warranty claims must be asserted within one year from the date of shipment of the subject items; thereafter warranty claims will not be honored. Purchaser's sole remedy for a warranty claim or otherwise shall be limited to repair or replacement of the subject product if it is shown to have been defective in material or workmanship at time of shipment. Starfire Lighting Inc.'s sole and maximum liability for a defective product shall not exceed the cost of the subject product. Except for such warranty and exclusive remedy as stated, (and the express warranty of title), we disclaim all other warranties, whether expressed or implied and specifically disclaim the implied warranties of merchantability and fitness for any particular purpose. In no event shall Starfire Lighting, Inc. be liable to Purchaser in warranty, contract negligence, strict liability or otherwise, for any damages, whether incidental or consequential which are alleged to be caused by one or more of Starfire Lighting, Inc.'s products, beyond the cost to the Purchaser of subject product or products. Therefore, the Purchaser's sole and exclusive remedy against Starfire Lighting, Inc. for breach of warranty, breach of contract or in negligence or in strict liability or otherwise shall be limited to repair or replacement of the subject product at our option (excluding installation and removal charges which shall not be Starfire Lighting, Inc.'s liability) or, refund of the purchase price. Warranty does not pass to the Purchaser until payment is received in full. In no case does the warranty and exclusive remedy extend to anyone other than the Purchaser. Purchaser is not authorized to extend warranties or remedies on Starfire Lighting, Inc.'s behalf to anyone. Such unauthorized extensions of warranties or remedies by the Purchaser shall remain the Purchaser's responsibility. Purchaser is responsible for determining the suitability of products for use or resale, or for incorporating them into objects or for application which Purchaser designs, assembles, constructs and manufactures.

Ballasts, emergency battery packs, lamps, and other such similar devices, may be covered by separate manufacturers' warranties. However Starfire Lighting, Inc. does not make any warranties whatsoever as to these items which are sold "AS IS," and Starfire Lighting, Inc. will accept no responsibility or liability whatsoever therefore.

**Transformer Noise:** Starfire Lighting, Inc. accepts no responsibility for transformer noise when used with dimmers or dimming systems.

**Changes In Specifications:** Starfire Lighting, Inc. reserves the right to make engineering or dimensional changes, without prior notification, to facilitate manufacturing methods; to the extent that such modifications do not compromise design integrity. Starfire Lighting, Inc. will not be obligated to modify fixtures manufactured prior to these changes.